

Short Right Angle Sanders, Buffers & Polishers for Surface Finishing Abrasives

300RA Series & 307RA Series

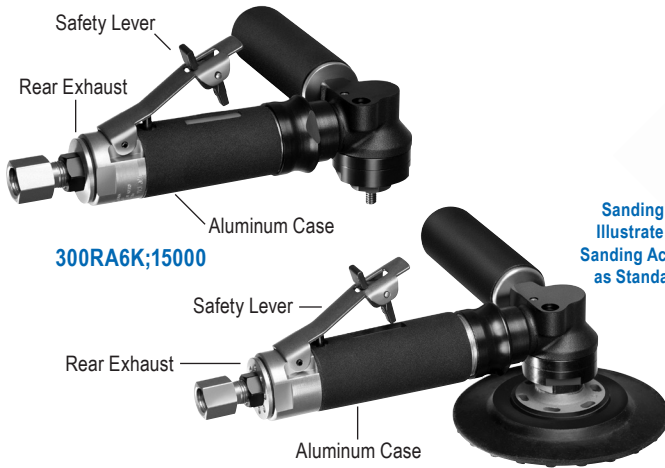

300RA6K;15000

307RA2K;10000;SP

Sanding Pads Shown on Tools to Illustrate the Sanding Application. Sanding Accessories are Not Supplied as Standard Equipment with Tools.

400RA Series & 407RA Series



400RA2R;10000;SP

400RA2K;10000;SP

RIGHT ANGLE SANDERS

Recommended Maximum Sanding Pad Size	Exhaust Direction	Spindle Output	Lever Style	Model Number
3 Inch (75 mm)	Rear	1/4-20	Standard Lever	300RA6;15000
			Safety Lever	300RA6K;15000
4 Inch (100 mm)		3/8-24	Standard Lever	307RA4;10000;SP
			Safety Lever	307RA4K;10000;SP
4 1/2 Inch (115 mm)		5/8-11	Standard Lever	300RA2;13000;SP
			Safety Lever	300RA2K;13000;SP
5 Inch (125 mm)	Standard Lever	307RA2;10000;SP		
	Safety Lever	307RA2K;10000;SP		

Recommended Maximum Sanding Pad Size	Exhaust Direction	Spindle Output	Lever Style	Model Number
4 Inch (100 mm)	Side	3/8-24	Standard Lever	400RA4;10000;SP
	Rear		Safety Lever	400RA4K;10000;SP
4 1/2 Inch (115 mm)	Side	5/8-11	Standard Lever	410RA2;13000;SP
	Rear		Safety Lever	410RA2K;13000;SP
5 Inch (125 mm)	Side	5/8-11	Standard Lever	400RA2;10000;SP
	Rear		Safety Lever	400RA2K;10000;SP
5 Inch (125 mm)	Side	5/8-11	Standard Lever	407RA2;8000;SP
	Rear		Safety Lever	407RA2K;8000;SP

The 307RA is available with rated speeds within the range of 7000 to 10000 RPM.

The 407RA is available with rated speeds within the range of 6000 to 8000 RPM.

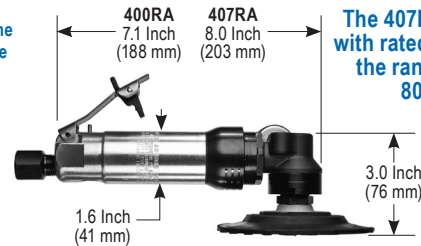
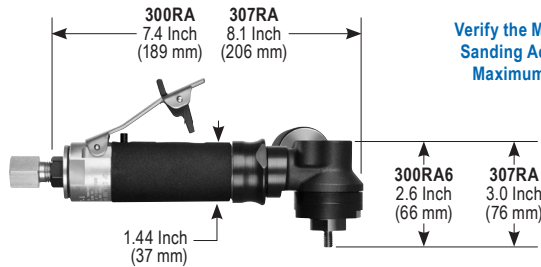

Verify the Maximum Rated Speed of the Sanding Accessory is Higher than the Maximum Rated Speed of the Tool.

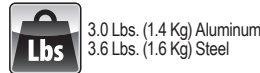
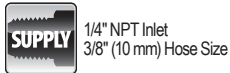
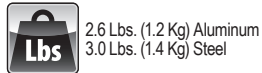
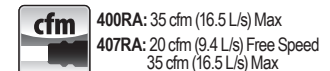
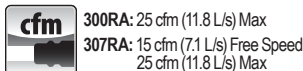

STANDARD EQUIPMENT

- Tool
- Operating Instructions and Service Manual
- Wrenches (sizes based on options)

300RA & 307RA Alternate Options

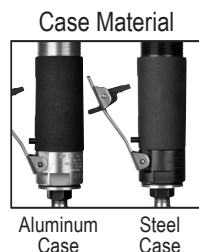

300-400RA & 307-407RA Alternate Options



400RA & 407RA Alternate Options



Surface Conditioning Abrasive Mounting

